

SOLUTIONS FOR GROWTH



# nT17BX06 CDPS-UC4H4HFS

4×4 HDMI 4K UHD Matrix  
with Control System Center



**Operation Manual**



## **DISCLAIMERS**

The information in this manual has been carefully checked and is believed to be accurate. Cypress Technology assumes no responsibility for any infringements of patents or other rights of third parties which may result from its use.

Cypress Technology assumes no responsibility for any inaccuracies that may be contained in this document. Cypress also makes no commitment to update or to keep current the information contained in this document.

Cypress Technology reserves the right to make improvements to this document and/or product at any time and without notice.

## **COPYRIGHT NOTICE**

No part of this document may be reproduced, transmitted, transcribed, stored in a retrieval system, or any of its part translated into any language or computer file, in any form or by any means—electronic, mechanical, magnetic, optical, chemical, manual, or otherwise—without express written permission and consent from Cypress Technology.

© Copyright 2017 by Cypress Technology.

All Rights Reserved.

## **TRADEMARK ACKNOWLEDGMENTS**

All products or service names mentioned in this document may be trademarks of the companies with which they are associated.





## SAFETY PRECAUTIONS

Please read all instructions before attempting to unpack, install or operate this equipment and before connecting the power supply.

Please keep the following in mind as you unpack and install this equipment:

- Always follow basic safety precautions to reduce the risk of fire, electrical shock and injury to persons.
- To prevent fire or shock hazard, do not expose the unit to rain, moisture or install this product near water.
- Never spill liquid of any kind on or into this product.
- Never push an object of any kind into this product through any openings or empty slots in the unit, as you may damage parts inside the unit.
- Do not attach the power supply cabling to building surfaces.
- Use only the supplied power supply unit (PSU). Do not use the PSU if it is damaged.
- Do not allow anything to rest on the power cabling or allow any weight to be placed upon it or any person walk on it.
- To protect the unit from overheating, do not block any vents or openings in the unit housing that provide ventilation and allow for sufficient space for air to circulate around the unit.

## REVISION HISTORY

VERSION NO.	DATE (DD/MM/YY)	SUMMARY OF CHANGE
VR0	24/09/15	Preliminary release
VR1	17/02/16	Release RS-232 Command case- insensitive
VS2	17/02/17	Updated text/diagrams



# CONTENTS

<b>1. Introduction</b> .....	<b>1</b>
<b>2. Applications</b> .....	<b>1</b>
<b>3. Package Contents</b> .....	<b>1</b>
<b>4. System Requirements</b> .....	<b>2</b>
<b>5. Features</b> .....	<b>2</b>
<b>6. Operation Controls and Functions</b> .....	<b>3</b>
6.1 Front Panel .....	3
6.2 Rear Panel.....	4
6.3 Remote Control.....	6
6.4 OLED Menu .....	7
6.5 IR Cable Pin Assignment.....	10
6.6 RS-232 Protocol.....	11
6.7 RS-232 and Telnet Commands .....	12
6.8 Telnet Control .....	18
6.9 WebGUI Control .....	20
6.9.1 Routing Settings.....	21
6.9.2 EDID Settings.....	23
6.9.3 Macro Settings .....	23
6.9.4 Command Settings.....	25
6.9.5 Trigger Settings .....	26
6.9.6 UART Settings .....	27
6.9.7 Network Settings .....	27
6.9.8 System Settings.....	28
<b>7. Connection Diagram</b> .....	<b>29</b>
<b>8. Specifications</b> .....	<b>31</b>
8.1 Technical Specifications .....	31
8.2 Video Specifications .....	32
<b>9. Acronyms</b> .....	<b>34</b>





## 1. INTRODUCTION

This 4×4 HDMI 4K UHD Matrix allows up to 4 HDMI sources to be displayed on any of up to 4 HDMI displays. The built-in fast switching technology greatly reduces the time required between switches before a newly selected source is live.

The included control system functionality provides access not only to direct but also indirect control interfaces for all of your devices. Direct control methods such as IR (with IR learning), RS-232, relay and DC triggers allow users to maintain traditional styles of control over devices while indirect device control is possible using telnet allowing users to control newer, more complicated devices.

The operation of the system can be easily managed through the included WebGUI by connecting with your PC, laptop or even a mobile device such as a tablet. Front-panel controls, with an OLED screen to display current settings, are available for hands-on control. Additionally Telnet, RS-232, and an IR remote are available control options.

## 2. APPLICATIONS

- Home Theater with Smart Home Control
- Demo Room Display
- Lecture Hall/Ballroom
- Public Commercial Display with Interactive Controls
- Security Monitoring with Control
- Information Board Display with System Controls

## 3. PACKAGE CONTENTS

- 1×4 by 4 HDMI 4K UHD Matrix with Control System Center
- 1×Remote Control (CR-138)
- 1×IR Learner Cable
- 1×IR Extender Cable
- 1×IR Blaster Cable
- 4×Terminal Block Connectors
- 1×5V/6A Power Adaptor

- 1×Power Cord
- 1×Rack Mount Ears (Set of 2)
- 1×Operation Manual

## 4. SYSTEM REQUIREMENTS

- HDMI input source equipment such as Blu-ray players, video game consoles or set-top boxes.
- HDMI receiving equipment such as HDTVs, monitors or audio amplifiers.
- Trigger input source equipment such as motion detection cameras, TVs, power switches, etc.
- An active internet connection from a switch or router for control of Ethernet devices.
- The use of “Premium High Speed HDMI” cables is highly recommended.

## 5. FEATURES

- HDMI v1.4a with 3D and 4K UHD support, DVI 1.0 compatible
- Supports 4 HDMI inputs and 4 HDMI outputs
- Supports resolutions up to 4K UHD: 3840×2160@24/25/30Hz & 3840×2160@50/60Hz (YUV 4:2:0), 4096×2160@24/25/30Hz & 4096×2160@50/60Hz (YUV 4:2:0)
- Supports pass-through of LPCM 2.0/5.1/7.1, bitstream, and HD bitstream audio formats
- Supports individual or global EDID management
- Supports HDCP 1.4 for all HDMI inputs and outputs
- Per-input HDCP support control: Choose between Standard and Apple mode (Apple mode allows for the display of non-HDCP required content from Apple devices on non-HDCP displays)
- Supports 1 IR Learning input, 8 IR Blaster outputs, 8 Trigger inputs, 8 Relay outputs, 2 COM ports, and 4 Ethernet ports
- Supports an IR learning function which captures the IR signal broadcast by your remote when you press a button for retransmission as a part of a macro



- Supports 8 trigger inputs with a voltage range of 0~15V (triggers at 5V)
- Supports baud rates up to 115,200bps
- Supports 10/100Mbps Ethernet network connections

## 6. OPERATION CONTROLS AND FUNCTIONS

### 6.1 Front Panel

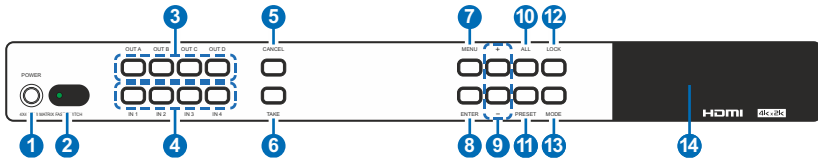

- 1 POWER:** Press this button to power the unit on or place it into stand-by mode.
- 2 IR WINDOW:** Accepts IR signals from the included IR remote for control of this unit only.
- 3 OUT A~D:** Press one or multiple “OUT” buttons followed by an “IN” button to select which outputs to route an input to. After making your selections press the “TAKE” button to confirm your new routing selection. E.g. OUT A→IN 1→TAKE (Input 1 is routed to Output A) or OUT A→OUT B→IN 4→TAKE (Input 4 is routed to Outputs A and B).  
*Note: “TAKE” is not required if you are in “Real Time” mode.*
- 4 IN 1~4:** Press an “IN” button to select an input from 4 sources.  
*Note: In preset mode, these are used to select from presets 1~4.*
- 5 CANCEL:** Press this button to cancel the selection in “TAKE” mode. (Exits input selection in “Real Time” [R.T.] mode.)
- 6 TAKE:** Press this button to confirm and activate the currently selected IN/OUT routing selection in “TAKE” mode. (Exits input selection in “Real Time” [R.T.] mode.)
- 7 MENU:** Press to enter the OLED menu, or to back out from menu items.
- 8 ENTER:** Press to confirm a selection within the OLED menu or to go deeper into a menu item.



- 9 +/-: Press these buttons to move up and down within menus.
- 10 ALL: Press this button to select all outputs simultaneously and enter input selection mode.
- 11 PRESET: Press this button to enter or exit "Preset" mode. The OLED will display "Preset N" where "N" is the currently selected preset. Pressing "IN 1~4" will change the selected preset. Pressing "TAKE" will activate the selected preset.
- 12 LOCK: Press this button to lock all buttons on the front panel. Press and hold for 3 seconds to release the lock function.
- 13 MODE: Press this button to switch between the TAKE and Real Time (R.T.) modes. The upper right corner of the OLED will show which mode you are currently using.
- 14 OLED: Displays input, output, status and menu information.

## 6.2 Rear Panel

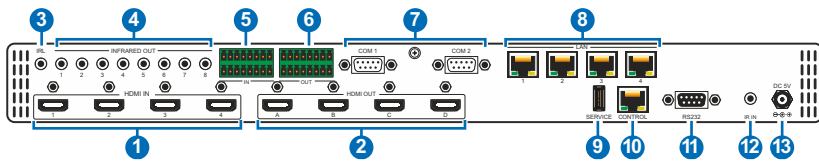

- 1 **HDMI IN 1~4:** Connect to HDMI source equipment such as Blu-ray players, game consoles or set-top boxes.
- 2 **HDMI OUT A~D:** Connect to HDMI equipped displays such as HDTVs or projectors for display of the HDMI input source signals.
- 3 **IR L:** Connect to the IR Learning Receiver included in the package. This is used to capture the IR signal broadcast by your remote when you press a button for retransmission as a part of a macro. The IR data will be captured and stored in a text format within the WebGUI. For IR learning instructions please refer to section 6.9.4.  
*Note: Both the IR Extender and IR Learner look similar. The IR Extender is more of a reddish color whereas the IR Learner has a brownish color and a red dot on the back to help distinguish it. Please pay extra attention when connecting and using them.*
- 4 **IR OUT 1~8:** Connect to the provided IR Blasters to transmit IR signals to devices within direct line-of-sight of the IR Blaster.



- 5 **TRIGGER IN 1~8:** Connect to any device with trigger or switch functionality such as window security alarms, motion detectors, door switches, etc. Each of the 8 trigger inputs will activate the associated macro when triggered. The upper row of contacts should be connected to the positive pins of your sources and the lower row of contacts should be connected to the negative pins. If the polarity is incorrectly aligned then the trigger won't activate. A minimum of 5V DC is required to activate the trigger.
- 6 **RELAY OUT 1~8:** Connect to devices that support DC 0~24V/5A relay trigger functionality to power or activate them via macro commands.
- 7 **COM 1~2:** Connect to RS-232 controllable devices to send commands to those devices via macros. It is also possible to send commands directly to your RS-232 connected devices via the Ethernet connection. To do this, connect to the Unit using a Telnet client via port 7501 (to send to COM 1) or port 7502 (to send to COM 2). Once connected, any typed commands will be sent directly to the appropriate COM port.
- 8 **LAN1~4:** Connect any one port to an active Ethernet network to allow it to control other devices on the network. The remaining 3 ports can be connected directly to other local devices you wish to control.
- 9 **SERVICE:** This slot is reserved for firmware update use only.
- 10 **CONTROL:** Connect directly, or through a network switch, to your PC/laptop to control the unit via Telnet/WebGUI.
- 11 **RS-232:** Connect directly to your PC/laptop to send RS-232 commands to control the device. Please refer to section 6.6 for more information.
- 12 **IR IN:** Connect the included IR Extender to extend the IR control range of the unit itself. Ensure that the remote being used is within direct line-of-sight of the IR Extender.
- 13 **DC 5V:** Plug the 5V DC power adapter into this port and connect it to an AC wall outlet for power.

## 6.3 Remote Control

- 1 **POWER:** Press this button to power on the device or place it into stand-by mode.
- 2 **OUT A~D:** Press one or multiple “OUT” buttons followed by an “IN” button to select which outputs to route an input to.
- 3 **IN 1~4:** Press an “IN” button to select an input from 4 sources.
- 4 **ALL:** Press this button to select all outputs simultaneously and enter input selection mode.
- 5 **TAKE:** Press this button to confirm and activate the currently selected IN/OUT routing selection in “TAKE” mode.
- 6 **CANCEL:** Press this button to cancel the selection in “TAKE” mode.
- 7 **PRESET:** Press this button to enter or exit “Preset” mode. The OLED will display “Preset N” where “N” is the currently selected preset. Pressing “IN 1~4” will change the selected preset. Pressing “TAKE” will activate the selected preset.
- 8 **LOCK:** Press this button to lock all button functions on the front panel. Press again to release the lock function.
- 9 **MENU:** Press to enter the OLED menu, or to back out from menu items.
- 10 **ENTER:** Press to confirm a selection within the OLED menu or to go deeper into a menu item.
- 11 **+/-:** Press these buttons to move up and down within menus.
- 12 **MODE:** Press this button to switch in between TAKE and Real Time (R.T.) mode.

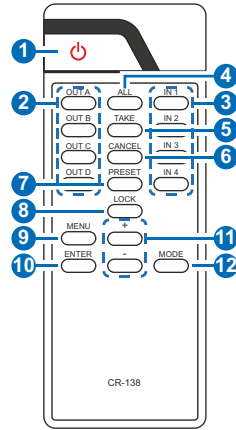

## 6.4 OLED Menu

MAIN MENU	SUB MENU	DESCRIPTION
EDID Mode	All	All input ports will use the same EDID. Select the EDID under the "EDID All" menu item.  Default: <b>All</b>
	Appoint	Each input can have its own EDID. Choose EDIDs within the "EDID IN1~4" menu items.
	Exit	
EDID All	Sink A	Copy EDID from outputs A~D.
	Sink B	
	Sink C	
	Sink D	
	8/2D/PCM/720P	Built-in EDIDs: Color bit depth/2D3D/Audio/Native resolution.  Default: <b>8/2D/PCM/1080P</b>
	8/2D/PCM/AC3/720P	
	8/2D/PCM/1080P	
	8/2D/PCM/AC3/1080P	
	8/2D/PCM/4K2K	
8/2D/PCM/AC3/4K2K		
Exit		
EDID IN1	Same as "EDID All"	Select individual EDIDs for Inputs 1~4.
EDID IN2		
EDID IN3		
EDID IN4		

MAIN MENU	SUB MENU	DESCRIPTION
Matrix Preset	Preset 1	Display or change routing presets 1~4. Default: <b>A=1, B=2, C=3, D=4</b>
	Preset 2	
	Preset 3	
	Preset 4	
	Exit	
HDCP Input	IN1 Standard/Apple	Set inputs 1~4 to Standard or Apple mode. Default: <b>Standard</b>
	IN2 Standard/Apple	
	IN3 Standard/Apple	
	IN4 Standard/Apple	
	Exit	
Network Setup	IP Mode: DHCP/Static	Set IP mode. Default: <b>Static</b>
	IP	Set static IP. Default: <b>192.168.1.50</b>
	Mask	Set static netmask. Default: <b>255.255.255.0</b>
	Gate	Set static gateway. Default: <b>192.168.1.254</b>
	Do Re-Link	After changing network settings, it is required to force a re-link for those settings to be used.
	Exit	
Network Status	Link	Network Status: DHCP, Static or Not Linked.
	IP	Display current IP address.
	Mask	Display current netmask.
	Gate	Display current gateway.
	MAC	Display MAC address.
	Exit	

MAIN MENU	SUB MENU	DESCRIPTION
Source Detection	IN1 On/Off	Display current inputs 1~4 detection status.
	IN2 On/Off	
	IN3 On/Off	
	IN4 On/Off	
	Exit	
Sink A Info	Type/Manufacturer/Model	Type=HDMI or DVI.
	Native	Display's native resolution.
	Video Format	Displays color bit depth, 2D/3D, and 4K support.
	Audio Format	Displays PCM, Bitstream, and HD Bitstream support.
	Exit	
Sink B Info	Same as "Sink A Info"	Same as "Sink A Info".
Sink C Info		
Sink D Info		
Firmware	FW Version	Display model number & FW version.
	Update	FW update.
	Exit	
Factory Reset	Do Reset	Perform a factory reset.
	Exit	
Exit		

## 6.5 IR Cable Pin Assignment

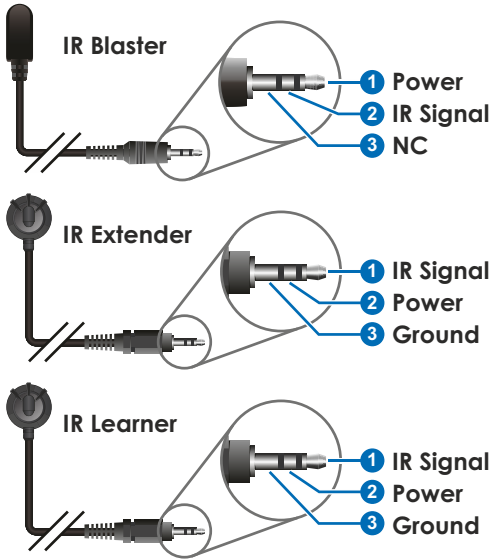

*Note: Due to the similarity of the IR Extender and IR Learner cables a part no. "CBL-IR10C3SA200A" sticker has been placed on the IR Learner to help differentiate it.*

## 6.6 RS-232 Protocol

MATRIX	
Pin	Assignment
1	NC
2	TXD
3	RXD
4	NC
5	GND
6	NC
7	NC
8	NC
9	NC



REMOTE CONTROLLER	
Pin	Assignment
1	NC
2	RXD
3	TXD
4	NC
5	GND
6	NC
7	NC
8	NC
9	NC

Baud Rate: 115200bps

Data Bits: 8

Parity: None

Flow Control: None

Stop Bits: 1



## 6.7 RS-232 and Telnet Commands

COMMAND	DESCRIPTION
<b>P0</b>	Power off. (Stand-by mode)
<b>P1</b>	Power on.
<b>IPCONFIG</b>	Display the current IP configuration.
<b>SIPADDR X.X.X.X</b>	Set Ethernet IP address. X=0~255
<b>SNETMASK X.X.X.X</b>	Set Ethernet Netmask. X=0~255
<b>SGATEWAY X.X.X.X</b>	Set Ethernet Gateway. X=0~255
<b>HTTPPORT N1</b>	Set HTTP port number. N1=10~65535
<b>TELNETPORT N1</b>	Set Telnet port number. N1=10~65535
<b>RSTIP</b>	Set IP configuration to DHCP.
<b>A N1</b>	Route input N1 to output A. N1=1~4
<b>B N1</b>	Route input N1 to output B. N1=1~4
<b>C N1</b>	Route input N1 to output C. N1=1~4
<b>D N1</b>	Route input N1 to output D. N1=1~4
<b>I N1</b>	Route input N1 to all outputs. N1=1~4
<b>EDIDMODE</b>	Show EDID mode.
<b>EDIDMODE N1</b>	Set EDID mode. N1=0~1 (0=Appoint, 1=All)

COMMAND	DESCRIPTION
<b>EDIDALL</b>	Show EDID source for "All" mode.
<b>EDIDALL N1</b>	Set EDID source for "All" mode.  N1=0~9 0=Sink A 1=Sink B 2=Sink C 3=Sink D 4=8/2D/PCM/720p 5=8/2D/PCM/AC3/720p 6=8/2D/PCM/1080p 7=8/2D/PCM/AC3/1080p 8=8/2D/PCM/4K2K 9=8/2D/PCM/AC3/4K2K
<b>EDIDIN</b>	Show each input's EDID source for "Appoint" mode.
<b>EDIDIN N1</b>	Show input N1's EDID source for "Appoint" mode.  N1=1~4
<b>EDIDIN N1 N2</b>	Set input N1's EDID source for "appoint" mode.  N1=1~4  N2=0~9 0=Sink A 1=Sink B 2=Sink C 3=Sink D 4=8/2D/PCM/720p 5=8/2D/PCM/AC3/720p 6=8/2D/PCM/1080p 7=8/2D/PCM/AC3/1080p 8=8/2D/PCM/4K2K 9=8/2D/PCM/AC3/4K2K

COMMAND	DESCRIPTION
<b>HDCPIN</b>	Show HDCP enable status for all inputs.
<b>HDCPIN N1</b>	Show HDCP enable status for input N1. N1=1~4
<b>HDCPIN N1 N2</b>	Set HDCP enable state for input N1. N1=1~4 N2=0~1 (0=Off, 1=On)
<b>PRESET</b>	Show all preset configurations.
<b>PRESET N1</b>	Activate preset N1. N1=1~4
<b>PRESET N1 N2</b>	Set routing configuration for preset N1. N1=1~4 N2=AxBxCxDx (x=1~4)
<b>SOURCEDET</b>	Show source detection status for all inputs.
<b>SOURCEDET N1</b>	Show source detection status for input N1. N1=1~4
<b>SINKINFO</b>	Show information about all outputs.
<b>SINKINFO N1</b>	Show information about output N1. N1=A~D
<b>INNAME</b>	Show names for all inputs.
<b>INNAME N1</b>	Show name for input N1. N1=1~4

COMMAND	DESCRIPTION
<b>INNAME N1 N2</b>	Set name for input N1. N1=1~4 N2={Name} (Up to 8 characters, no spaces)
<b>OUTNAME</b>	Show names for all outputs.
<b>OUTNAME N1</b>	Show name for output N1. N1=A~D
<b>OUTNAME N1 N2</b>	Set name for output N1. N1=A~D N2={Name} (Up to 8 ASCII characters, no spaces)
<b>MATRIXMODE</b>	Show current matrix mode.
<b>MATRIXMODE N1</b>	Set matrix mode. N1=0~1 (0=Real-time, 1=Take)
<b>VER</b>	Show unit's firmware version.
<b>REBOOT</b>	System reboot.
<b>HELP</b>	Show command list.
<b>?</b>	Show command list.
<b>HELP N1</b>	Show description of command. N1={Command Name}
<b>? N1</b>	Show description of command. N1={Command Name}
<b>FADEFAULT</b>	Set all configurations to factory default.
<b>ETH_FADEFAULT</b>	Set all Ethernet settings to factory default.
<b>CMDTBL SHOW</b>	Show full command list. (128 total)
<b>CMDTBL SHOW N1</b>	Show contents of command N1. N1=1~128

COMMAND	DESCRIPTION
<b>CMDTBL ADD N1 N2</b>	Change contents of command N1. N1=1~128 N2={Command string} (Up to 439 ASCII characters)
<b>CMDTBL DEL N1</b>	Delete the contents of command N1. N1=1~128
<b>CMDTBL NAME N1 N2</b>	Change the name of command N1. N1=1~128 N2={Name} (Up to 24 ASCII characters, spaces allowed)
<b>MACRO RUN N1</b>	Execute macro N1. N1=1~8
<b>COMCONF COM N1 N2 N3 N4 N5</b>	Set the RS-232 COM port configuration. N1=1~2 (COM Port) N2=4800~115200 (Baud Rate) N3=7~8 (Data Bits) N4=NONE, ODD, EVEN (Parity) N5=1~2 (Stop Bits)
<b>COMSEND COM N1 N2</b>	Send a command to the designated COM port. N1=1~2 (COM Port) N2={Command Data} (Up to 100 ASCII characters)
<b>IREMIT IR N1 N2 N3</b>	Send IR code to designated output port. N1=1~8 (IR Port) N2=0 (Format) N3={IR Data String}

COMMAND	DESCRIPTION
<b>IRLEARN N1</b>	Capture and then display the IR code from an IR remote button press. N1=0 (Format)
<b>RELAY N1 N2</b>	Set relay N1's state. N1=1~8 N2=OPEN, CLOSE, TOGGLE
<b>TRIGGER STATUS N1</b>	Show trigger N1's state. N1=1~8
<b>TRIGGER INFO N1</b>	Show trigger N1's configuration info. N1=1~8
<b>TRIGGER ACTIVE N1 N2</b>	Enable or disable trigger N1. N1=1~8 N2=ENABLE, DISABLE
<b>TRIGGER MODE N1 N2</b>	Set trigger N1's activation method. N1=1~8 N2=RAISING, FALLING, CHANGE

Note:

- *Commands will not be executed unless followed by a carriage return. Commands are not case-sensitive.*
- *Some CMDTBL & COMSEND commands may require carriage returns or other normally "illegal" characters within the sent Command Data. To send those characters the ASCII hex value can be used when preceded by "\x". For example, "\x0D" would be transmitted as a standard carriage return. Because "\" will interpreted as a special escape character, please type "\\\" if a "\" needs to be sent within the command.*

## 6.8 Telnet Control

Before attempting to use telnet control, please ensure that both the unit and the PC/Laptop are connected to the same active networks.

To access Telnet in Windows 7, click on the "Start" menu and type "cmd" in the search field, then press "Enter". Under Windows XP go to the "Start" menu, click on "Run", type "cmd" then press "Enter". Under Mac OS X, go to "Go→Applications→Utilities→Terminal". See below for reference.

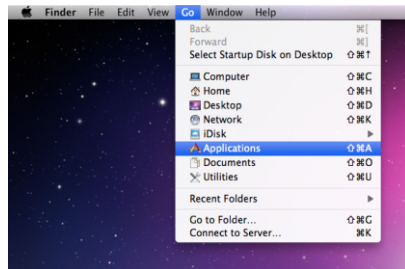
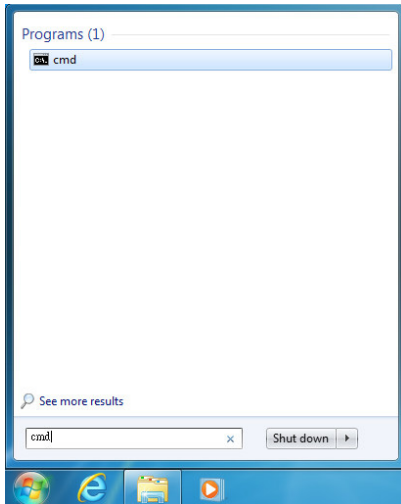

Once in the CLI (Command Line Interface) type "telnet" followed by the IP address of the unit and "23", then hit "Enter".

```
Microsoft Windows [Version 6.1.7601]
Copyright (c) 2009 Microsoft Corporation. All rights reserved.

C:\Users\Administrator>telnet 192.168.5.80 23
```



This will connect us to the unit we wish to control. Type “help” to list the available commands.

```
P0      : POWER OFF
P1      : POWER ON
IPCONFIG : DISPLAY THE CURRENT IPCONFIG
SIPADDR : SET ETHERNET IP ADDRESS
SNETMASK : SET ETHERNET NETMASK
SGATEWAY : SET ETHERNET GATEWAY
HTTPPORT : SET HTTP PORT NUMBER
TELNETPORT : SET TELNET PORT NUMBER
RSIIP    : IP CONFIGURATION RESET TO <DHCP>
A        : SET OUTPUT A SOURCE
B        : SET OUTPUT B SOURCE
C        : SET OUTPUT C SOURCE
D        : SET OUTPUT D SOURCE
I        : SET ALL OUTPUTS SOURCE
EDIDMODE : EDID MODE
EDIDALL  : EDID MODE SOURCE FOR ALL
EDIDIN   : INPUT EDID SOURCE
HDCPIN   : INPUT HDCP STATUS
PRESET   : MATRIX PRESET CONFIGURATION
SOURCEDET : SOURCE SIGNAL DETECT <ON/OFF>
SINKINFO : SINK INFORMATION
INNAME   : INPUT NAME
OUTNAME  : OUTPUT NAME
MATRIXMODE : MATRIX SWITCH MODE SETTING
REBOOT   : SYSTEM REBOOT
?        : SHOW DESCRIPT OF COMMAND
HELP     : SHOW DESCRIPT OF COMMAND
FAEFAULT : ALL CONFIGURE SET TO FACTORY DEFAULT
ETH_FAEFAULT : ALL ETHERNET CONFIGURE SET TO FACTORY DEFAULT
UER      : Print version number of all devices.
COMSEND  : Send desired data to specified COM port.
IREMIT   : Emit IR code to specified IR output port.
RELAY    : Set relay state to specified relay port.
TRIGGER  : Trigger-in behavior mode and status report.
IRLEARN  : IR remote controller signal learning.
COMCONF  : COM port configuration.
MACRO    : Control system macro manipulation
CMDTBL   : Control system command list table manipulation.
```

Note:

- *Commands will not be executed unless followed by a carriage return. Commands are not case-sensitive.*
- *If the IP address is changed then the IP address required for Telnet access will also change accordingly.*



## 6.9 WebGUI Control

- **Install the Device Discovery Tool**

Find Devices on Network			
Product Name	Description	IP Address	MAC Address

Please obtain the Device Discovery software from your authorized dealer and save it in a directory where you can easily find it. Connect the unit and your PC/Laptop to the same active network and execute the Device Discovery software. Click on "Find Devices on Network" and a list of devices connected to the local network will show up indicating their current IP address.

*Note: The unit's default static IP address is 192.168.1.50*

Product ID	
Product Name	
MAC Address	00:00:00:00:00:00
IP Address	<input type="text"/>
Subnet Mask	<input type="text"/>
Gateway IP	<input type="text"/>
DNS	<input type="text"/>
IP Mode	Static
Web GUI Port	0
Telnet Port	0
S / N	
Firmware Version	
Hardware Version	
Description	
Web GUI	<a href="#">Web GUI</a>
<input type="button" value="Save"/> <input type="button" value="Reboot"/>	

By clicking on one of the listed devices you will be presented with the network details of that particular device. If you choose, you can alter the static IP network settings for the device, or switch the unit into DHCP mode to automatically obtain proper network settings from a local DHCP server. To switch to DHCP mode, please select DHCP from the IP mode drop-down, then click "Save" followed by "Reboot".

Once you are satisfied with the network settings, you may use them to connect via Telnet or WebGUI. The network information window provides a convenient link to launch the WebGUI directly.

- Login to the WebGUI

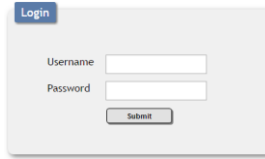

Open a web browser on a PC/Laptop that is connected to an active network and type the unit's IP address (available from the OLED menu) into the web address entry bar. The login screen will appear and ask for a Username and Password. The default username and password is "admin". Please enter the information and then click "Submit" to log in.

*Note: The unit's default IP address is 192.168.1.50*

On the left side of the browser you will see the following menu tabs: Routing Settings, EDID Settings, Macro Settings, Command Settings, Trigger Settings, UART Settings, Network Settings, and System Settings to allow for user configuration of the unit.

### 6.9.1 Routing Settings

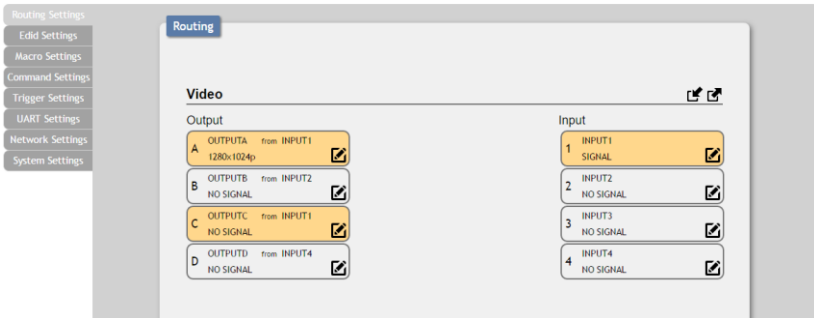

Click on the "Routing Settings" tab to control the matrix routing functions of this unit. To begin assigning a new video route, please click the button of the output you wish to send video to (e.g. "OUTPUTA") and then click on the button of the preferred input port (e.g. "INPUT1"). If desired, you may select more than one output prior to selecting the input. As you select each button it will change its color to orange. The new route will become active immediately after selecting the input and the routing information displayed on the buttons will change accordingly.

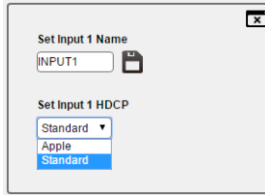

- (1) **Renaming I/O:** All inputs and outputs can be renamed as required (up to 8 characters long). Click on the “Edit” icon (✎) to change the input and output port names. Click on the “Save” icon (💾) to confirm the changes.
- (2) **Setting HDCP:** You may also set the HDCP mode for each input here. Choose between “Standard” and “Apple” mode. Apple mode allows for the display of non-HDCP required content from Apple devices on non-HDCP displays. Click on the “Save” icon (💾) to confirm the changes.

**Presets:** This matrix can store up to four routing presets. Presets can be utilized to store multiple different routing states in advance for rapid, hassle-free, recall.



- (1) **Store:** Once you have the matrix set the way you like, you can click the “Preset Import” icon (💾) in the upper right corner of the window. This will present you with a new window allowing you to choose one of four preset slots to save your current configuration to. After selecting the number the preset will be stored and the window will close.
- (2) **Recall:** When you wish to load a previously stored setting, please click the “Preset Export” icon (✎) and you will be presented with a choice of the four available presets. The preset will load immediately upon selecting the preset number and the window will close.

## 6.9.2 EDID Settings

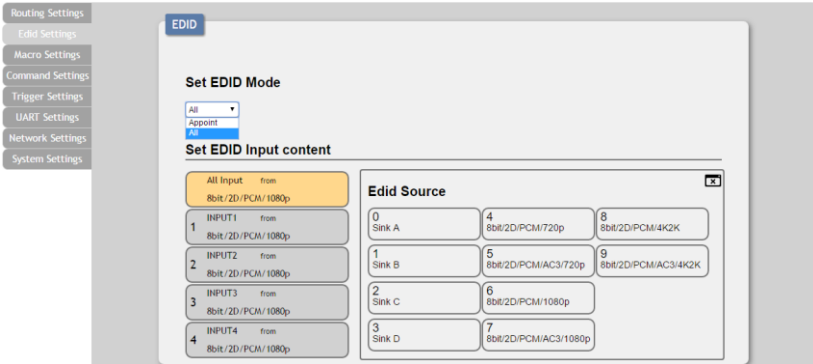

Click on the "EDID Settings" tab to select the EDID mode and the EDID(s) to use. Select "All" to pick a single EDID to be sent to all inputs. Select "Appoint" to pick individual EDIDs for each input. You can choose to use the EDID from one of your connected display devices, or you may choose from one of the built in EDIDs.

## 6.9.3 Macro Settings

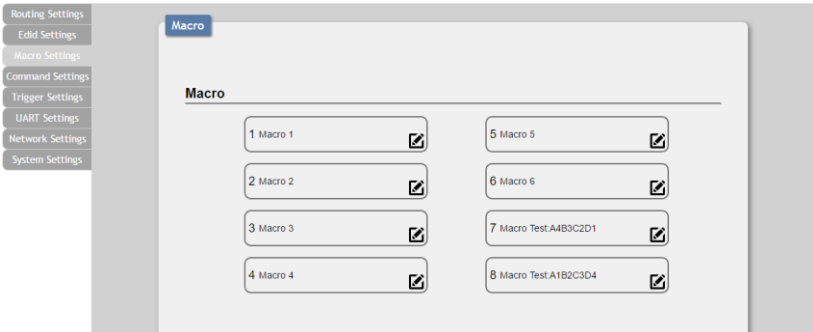

Click on the "Macro Settings" tab to execute/edit the 8 available macros. These macros can be executed by activating the 8 input triggers on the back of the unit as well as via the WebGUI or Telnet. Each macro can contain up to 16 individual commands.

Macros 1~8 align with Trigger IN 1~8. When a trigger signal is detected the unit will execute the associated macro command.

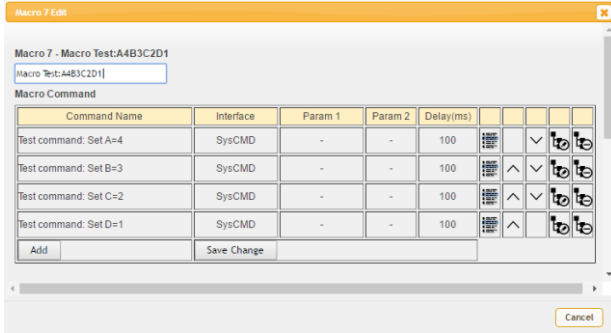

Click on the "Edit" icon (✎) to edit each button's macro. At the top of the Macro edit window is a text field where you can edit the name of the macro. Type your new macro name into the box and it will be saved when the macro is saved.

Within the Macro edit window the up/down arrows will change the command execution order. The (🔍) icon allows you to edit the delay and interface for the command. The (🗑️) icon will delete the command.

Click on the (🔍) icon to insert a new command before the current one. Select one of the pre-defined commands from the list. (Details on how to create these pre-defined commands are later in this section.) After selecting a command, you will need to choose the delay and interface for the command.

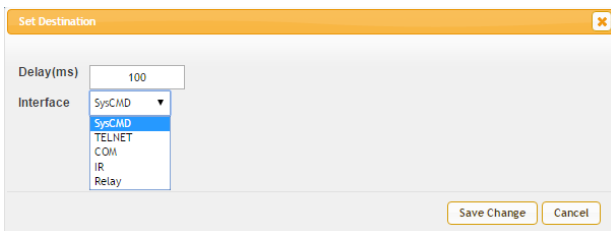

**(1) Delay(ms):** This setting is the length of time to wait before sending the next command and is set in milliseconds.

**(2) Interface:** The interface for sending commands can be set to the unit itself (SysCMD), to a specified IP address (TELNET), to a specified RS-232 port (COM), to a specified IR port (IR) or to trigger a relay port (Relay). Sending commands to devices on the local

network, or across the internet requires the IP address and network port number of the destination device.

Once the destination information is complete please click on the “Save Change” button.

*Note: It is strongly suggested to not set a delay time less than 100ms for system, RS-232, IR, and relay commands or less than 500ms for Telnet commands to ensure that the command is properly received and executed before the next command is sent.*

When you have finished editing the macro click on “Save Change”.

### 6.9.4 Command Settings

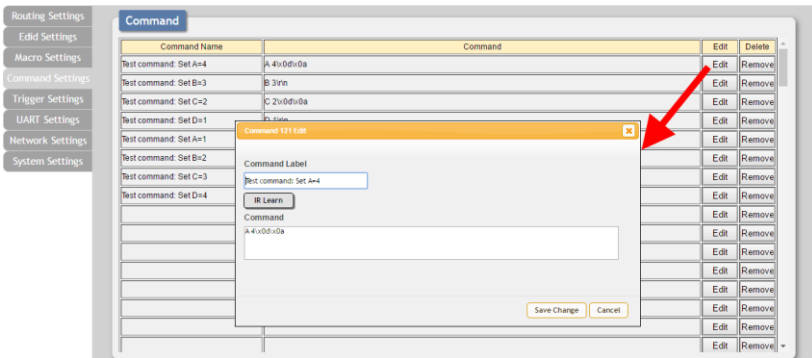

Click on the “Command Settings” tab to create, edit or delete commands. The number of commands that can be stored in the unit is limited by memory. It is generally recommended that commands be under 128 characters long (including spaces). However, if longer commands are needed there is limited support for commands up to 512 characters long. In this case the number of (up to) 512 character commands is limited to 32 and the remaining 96 commands must be under 128 characters.

- (1) Renaming Command:** You may rename the command, if you wish, by changing the text in the “Command Label” field.
- (2) Learning IR Command:** To learn an IR command, first make sure the included IR Learner is connected to the unit’s IRL port, then press “IR Learn” within the command edit window. After doing this a notice will appear in the WebGUI to send the IR signal within 5 seconds. When you see this, point your remote control at the IR receiver and press the button that contains the command you

wish to learn. A command string will then appear in the text entry window containing the information captured from the IR remote.

**(3) Entering Text Command:** For plain text commands, simply enter the text command into the entry window.

Once the command setting is complete please click on the "Save Change" button to save the new command.

*Note: Some commands may require a carriage return (e.g. \r or \x0D) at the end to be accepted by the destination device.*

### 6.9.5 Trigger Settings

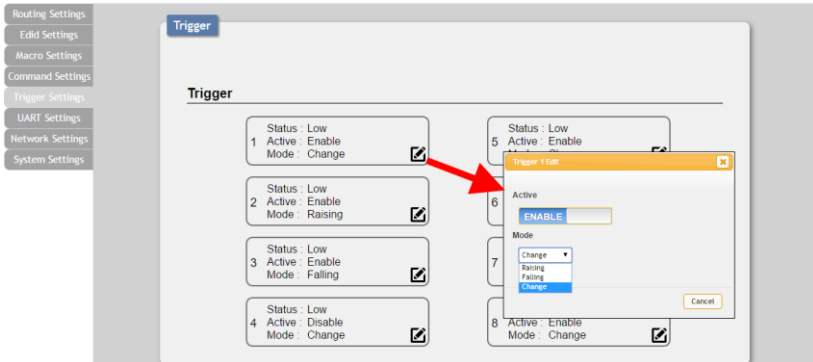

Click on the "Trigger Settings" tab to view the current trigger status and edit trigger behavior. Each trigger has 3 indicators: Status, Active, and Mode.

- (1) Status:** This item indicates the current input connection signal state. A status of "Low" indicates no voltage, or that the voltage detected is below the 5V threshold. "High" indicates that the detected voltage is above the 5V threshold.
- (2) Active:** This item indicates if the trigger's functionality is enabled or not. This setting can be changed by clicking on the "Edit" icon (🔍).
- (3) Mode:** This item indicates the currently selected trigger activation method. The three available options are "Raising", "Falling" and "Change". "Raising" triggers when the signal transitions from low to high, "Falling" triggers when the signal transitions from high to low, and "Change" triggers any time the state changes, regardless of direction. This setting can be changed by clicking on the "Edit" icon (🔍).

## 6.9.6 UART Settings

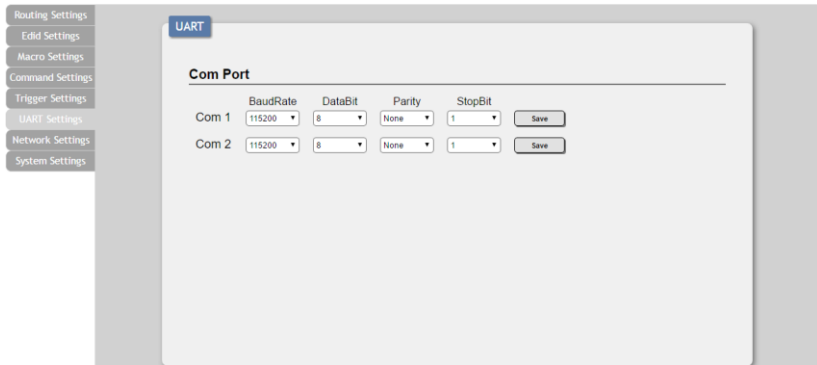

Click on the “UART Settings” tab to configure each COM port's Baud Rate, Data Bit, Parity, and Stop Bit. Values that can't be directly selected here may be set via Telnet or RS-232. After changing a COM port's settings please click on the “Save” button to store the new settings.

## 6.9.7 Network Settings

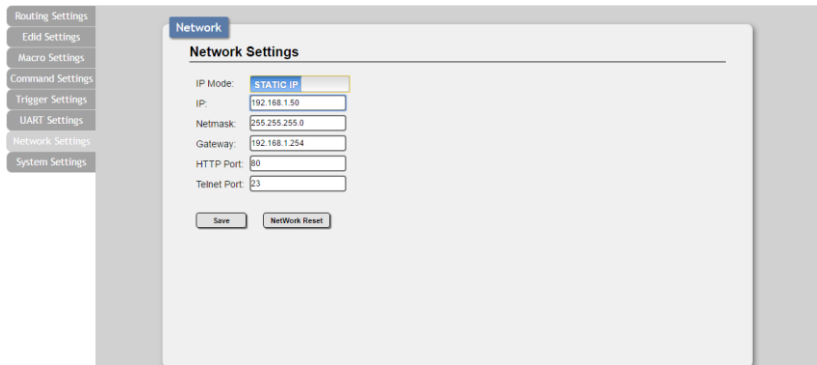

Click on the “Network Settings” tab to change the network settings for the unit. You can manually set the IP address, netmask, and gateway address in “Static IP” mode, or you can obtain an IP address automatically by enabling DHCP. You may also change the default HTTP and Telnet ports used by the unit here. Click on the “Save” button to save your updated network settings.



## 6.9.8 System Settings

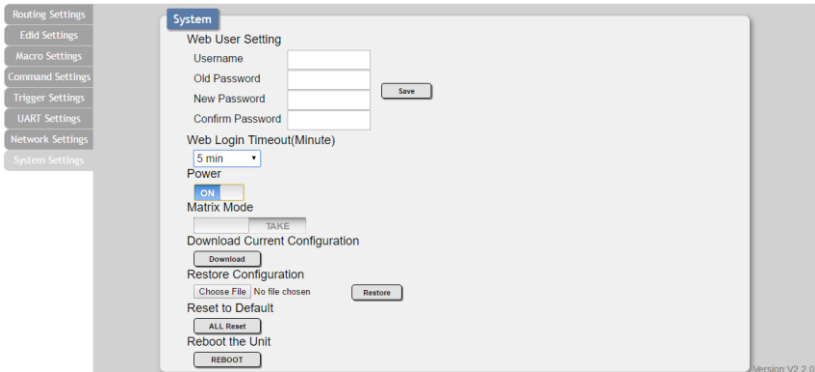

Click on the “System Settings” tab to make changes to various system settings. From this tab you can change the WebGUI login password, login timeout settings, power the unit on/off (stand-by), and switch the matrix mode between Take and Real Time mode. You may also save the full system configuration, including all macros, to your connected PC/Laptop or restore them from a previously saved configuration. Finally, this tab provides buttons to reset the unit to factory defaults and to reboot the unit.

*Note: Please ensure that all commands and settings have been backed up before performing an “All Reset” as the procedure will return all settings back to the factory default.*

## 7. CONNECTION DIAGRAM

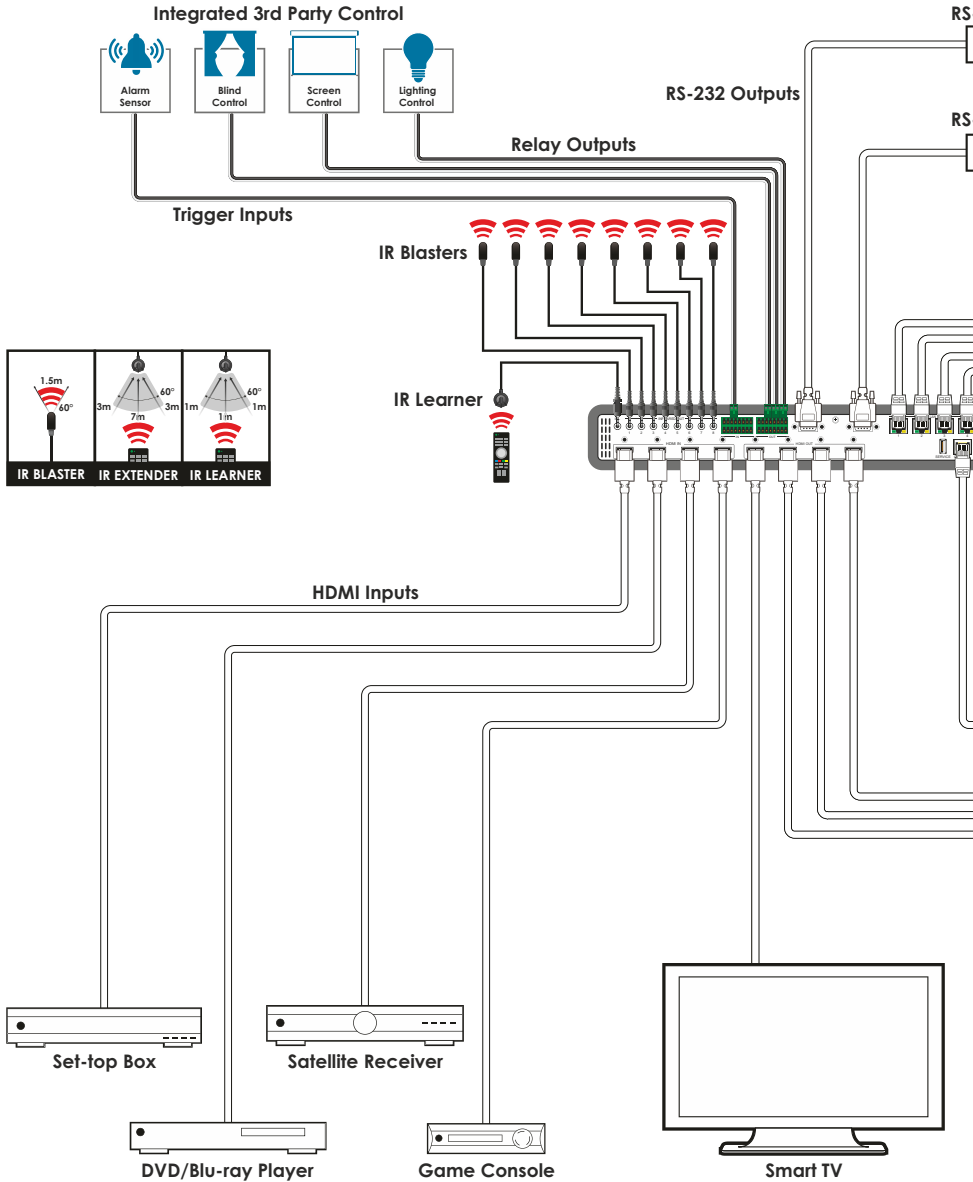

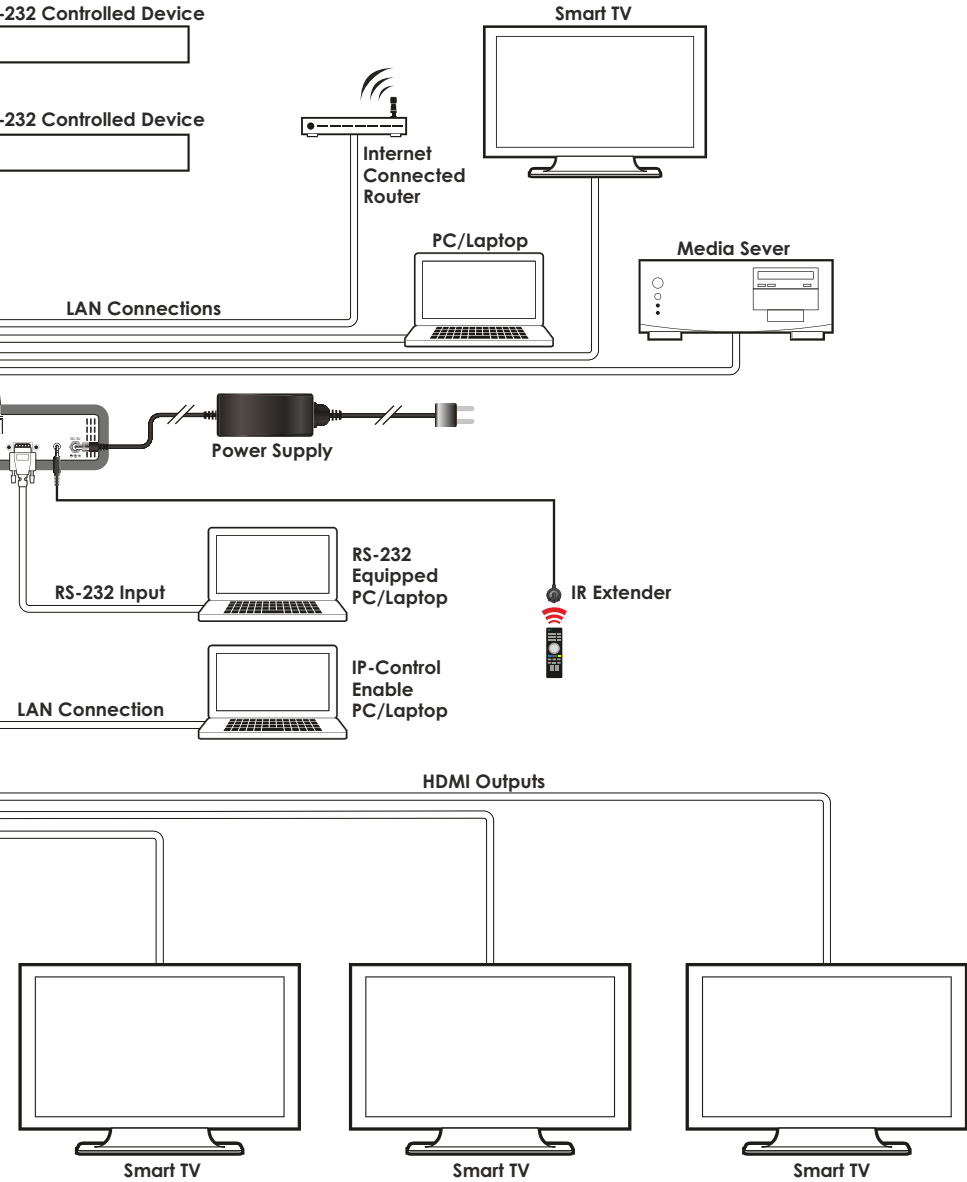



## 8. SPECIFICATIONS

### 8.1 Technical Specifications

<b>Video Bandwidth</b>	340MHz/10.2Gbps
<b>Input Ports</b>	4×HDMI, 1×IR Learner (3.5mm), 1×IR Extender (3.5mm), 8×Trigger (2-pin Terminal Block)
<b>Output Ports</b>	4×HDMI, 8×IR Blaster (3.5mm), 8×Relay (2-pin Terminal Block), 2×COM (9-pin D-sub), 4×LAN (RJ45) 1×IP Control (RJ45), 1×RS-232 (9-pin D-sub)
<b>Supported Resolutions</b>	408i@60Hz - 4K@60Hz (4:2:0) VGA@60Hz - WUXGA@60Hz (RB)
<b>HDMI Cable Length</b>	10m (1080p@60Hz, 12-bit) 5m (4K@60Hz, 4:2:0, 8-bit)
<b>IR Frequency</b>	30 - 50kHz (30 - 60kHz under ideal conditions)
<b>Baud Rate</b>	Up to 115200bps
<b>Power Supply</b>	5V/6A DC (US/EU standards, CE/FCC/UL certified)
<b>ESD Protection</b>	Human Body Model: ±12kV (Air Discharge) ±8kV (Contact Discharge)
<b>Dimensions</b>	438mm×44mm×269mm (W×H×D) [Case Only] 482mm×49mm×276mm (W×H×D) [All Inclusive]
<b>Weight</b>	3,258g
<b>Chassis Material</b>	Metal
<b>Silkscreen Color</b>	Black
<b>Operating Temperature</b>	0°C - 40°C/32°F - 104°F

<b>Storage Temperature</b>	-20°C - 60°C/-4°F - 140°F
<b>Relative Humidity</b>	20 - 90% RH (No-condensing)
<b>Power Consumption</b>	16.5W

## 8.2 Video Specifications

Supported Resolutions (Hz)	Input	Output
640×480@60/72/75/85		
720×400@85		
800×600@56/60/72/75/85		
1024×768@60/70/75/85		
1152×864@75		
1280×720@60		
1280×768@60/75/85		
1280×800@60/60 (RB)		
1280×960@60		
1280×1024@60		
1360×768@60		
1366×768@60		
1400×1050@60/60 (RB)		
1440×900@60/60 (RB)		
1600×900@60		
1600×1200@60		
1680×1050@60/60 (RB)		
1920×1080@60		
1920×1200@60 (RB)		
720×480i@50		
720×576i@60		
720×480p@60		

Supported Resolutions (Hz)	Input	Output
720×576p@50		
1280×720p@50/60		
1920×1080i@50/60		
1920×1080p@24/25/30/50/60		
3840×2160p@24/25/30		
3840×2160p@50/60 (YUV 4:2:0)		
4096×2160p@24/25/30		
4096×2160p@50/60 (YUV 4:2:0)		

## 9. ACRONYMS

ACRONYM	COMPLETE TERM
<b>CLI</b>	Command Line Interface
<b>DVI</b>	Digital Visual Interface
<b>EDID</b>	Extended Display Identification Data
<b>GUI</b>	Graphical User Interface
<b>HD</b>	High-Definition
<b>HDCP</b>	High-bandwidth Digital Content Protection
<b>HDMI</b>	High-Definition Multimedia Interface
<b>HDTV</b>	High-Definition Television
<b>HTTP</b>	HyperText Transfer Protocol
<b>IR</b>	Infrared
<b>LAN</b>	Local Area Network
<b>LPCM</b>	Linear Pulse-Code Modulation
<b>OLED</b>	Organic Light-Emitting Diode
<b>PC</b>	Personal Computer
<b>PCM</b>	Pulse-Code Modulation
<b>UHD</b>	Ultra-High-Definition
<b>USB</b>	Universal Serial Bus
<b>VGA</b>	Video Graphics Array (640×480@60Hz)
<b>WUXGA</b>	Wide Ultra Extended Graphics Array (1920×1200@60Hz)



**CYPRESS TECHNOLOGY CO., LTD.**

[www.cypress.com.tw](http://www.cypress.com.tw)